

Longopac® Bin

– simply smarter



Practical and
hygienic solution
for efficient waste
management
in public
environments

- Hygienic
- Efficient
- Environmentally friendly



Longopac Bin facilitates waste sorting and waste management in public environments in a neat, simple and environmentally friendly manner.

Bin Bullet is a practical and hygienic solution for efficient waste management. The unique bagging system also makes the Bin Bullet economical and environmentally friendly, as well as easy to use and time-saving.

The bin is easy to remove and bag change is quick. Thanks to its stylish design, the Bin Bullet blends into public environments such as restaurants, cafés, hotel lobbies and waiting rooms.

Bin Multi is a modular system for waste management and sorting at source. The system can be combined with different fractions; the cabinets are customised for 1–4 fractions according to the customer's requirements.

Bin Multi is suitable for areas that require efficient sorting at source, such as corridors, kitchenettes and conference rooms. The cabinet can, of course, be placed in any dry environment. The cabinet is also available in the very popular, special version for disposable cups.

Bin Multi does not take up much more space than a large waste basket but the Longopac bagging system that is used inside all the cabinets makes waste management

more efficient and reduces both costs and environmental impact.

Each piece of furniture is equipped with a decal on the top with information about what should be thrown in each aperture.

What all cabinets have in common is the Longopac system. The system really comes into its own when sorting at source, since it is possible to change the bags for all fractions and only use the exact amount of film needed for each fraction. The cabinet is emptied without half empty bags being thrown away.

The product is made in Sweden. The material is melamine and high pressure laminate. The modular pieces of furniture are available in the colours white and grey. Other colours are available by special order.

Both Bin Bullet, Multi and Tower are loaded with Longopac cassette Mini, which is available in different strengths and colours. The cassette is also available in 100 % compostable material for food waste; Longopac Biodegradable.



Bin Bullet, white



Bin Bullet, replacement of bag cassette



Bin Bullet, black

Product name	Part no	Colour	Dimensions	Weight
Bin Bullet	35100 35200	Black White	Height: 860 mm Width: 380 mm Opening: Ø 200 mm	8 kg fully assembled 5 kg bin
Longopac Multi 1	36010 36011	White Grey	Height: 1000 mm Width: 430 mm Depth: 440 mm Opening: See separate diagram	30 kg
Longopac Multi 2	36020 36021	White Grey	Height: 1000 mm Width: 565 mm Depth: 440 mm Opening: 100x220 mm	32 kg
Longopac Multi 3	36030 36031	White Grey	Height: 1000 mm Width: 820 mm Depth: 440 mm Opening: 100x220 mm	33 kg
Longopac Multi 4	36040 36041	White Grey	Height: 1000 mm Width: 1075 mm Depth: 440 mm Aperture: 100x150 mm Opening: 100x220 mm	36 kg
Longopac Multi Cup	36100 Small 78 mm 36101 Small 78 mm 36110 Medium 80 mm 36111 Medium 80 mm 36120 Large 82 mm 36121 Large 82 mm	White Grey White Grey White Grey	Height: 1000 mm Width: 430 mm Depth: 440 mm Opening: .. 4 apertures (78, 80, 82) Enter cup diameter.	30 kg
Longopac Bin Tower	36000 36001 36002 36003 36004	White Grey Beech Oak Birch	Height: 1120 mm Width: 430 mm Depth: 450 mm Opening: 200x200 mm	35 kg

Solutions for indoor use



Bin Multi 1 closed and in open position below



Bin Multi 2 closed and in open position below



Bin Multi 3 closed and in open position below



Bin Multi 4 in closed position



Bin Multi Cup in closed position



Bin Tower in closed position

Solutions for indoor use



Bin Multi 4 in various open positions



Bin Multi Cup in various open positions and with a pull-out lower section



Bin Tower in various open positions and with a shelf underneath



The top of the Multi 2-4 cabinet can be lifted up, simplifying loading of a new cassette. Both the doors and the top panel of the Multi products can be opened during bag change, if required.

Multi Cup has an insert in which cups are stacked inside each other, with each bag holding up to 400 cups. Several different cup diameters are available. The system saves a lot of space compared with an ordinary waste container. Multi Cup also has a separate pull-out drawer for residual waste.

Bin Tower is a versatile, tall cupboard with a removable shelf.

When combined with Longopac Biodegradable, the shelf functions as a separator where the bottom half of the cupboard can be used for storage and as a supporting platform for cassette. Ideal for messy or heavy waste.

HYGIENIC

- No waste ends up outside the bag.
- No waste on the floor – not even during bag change.
- No contact with the waste.

EFFICIENT

- Loaded with a 60 metre bag cassette.
- New bag always in place.
- Bag always securely sealed.
- Quicker bag changes.
- Flexible service intervals.
- Less cleaning.
- Always 100 % fill level.

ENVIRONMENTALLY FRIENDLY

- The Longopac bag material is made from 3-ply polyethylene, which combines low consumption of raw material with a high level of strength.
- Customers can calculate their environmental saving using the Paxxos CO₂ calculator and Paxxo is able to issue CO₂ emission certificates of the CO₂ saving.



Longopac Biodegradable

Standard Color codes

0	2
1	4
	5
	6

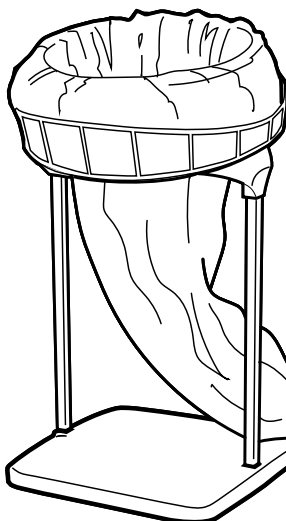

HOW IT WORKS

Step 1:

The bag cassette is sealed at one end with a cable tie. Once the bag starts to fill up, or when you want to replace the bag, all you have to do is pull it down and new material is dispensed from the cassette, making the bag longer.



Step 2:

To make a new bag, pull down the bag material and seal it at the top with a cable tie.



Step 3:

Attach another cable tie above the first one and cut off the bag material-between the ties.



The entire process takes no more than 30 seconds!

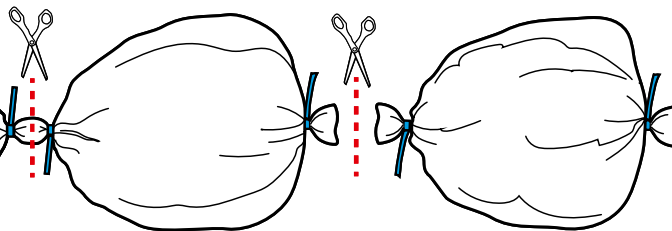
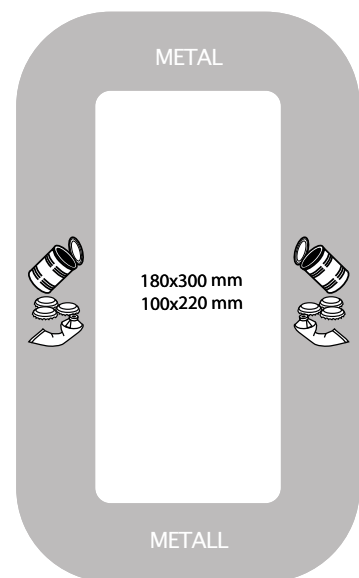
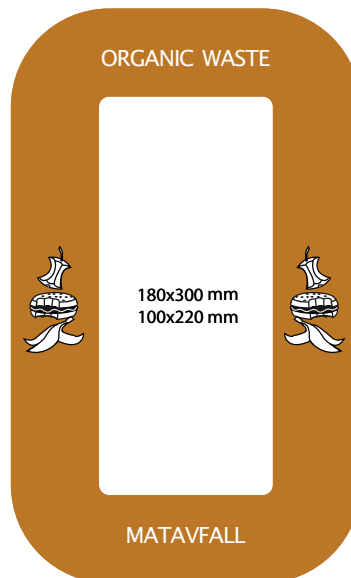
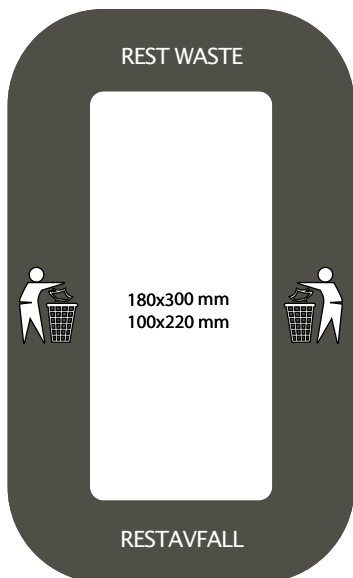
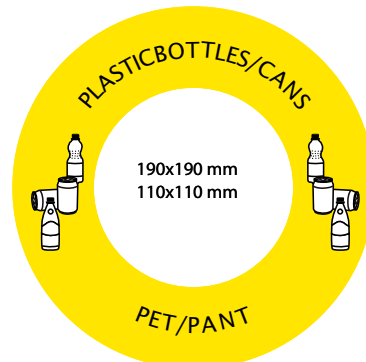
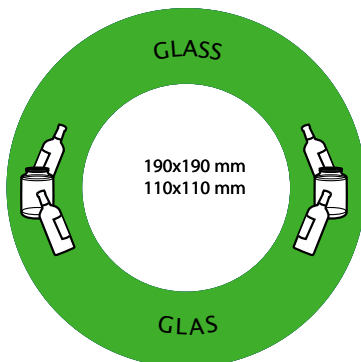
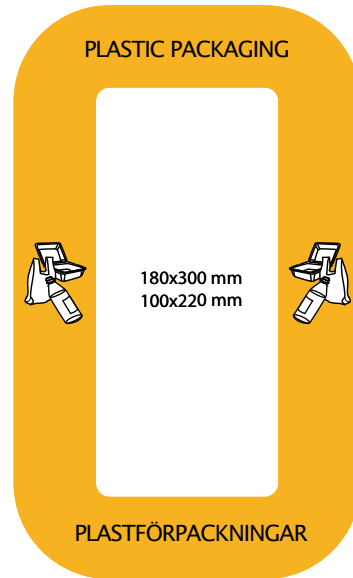
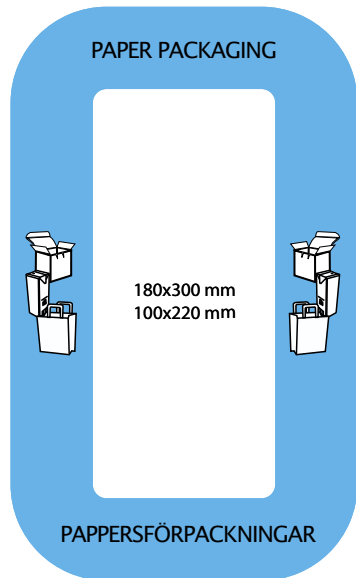

Diagram of openings



www.longopac.com



Paxxo AB • Bjurögatan 35, SE-211 24 Malmö, Sweden
www.paxxo.com • Tel: +46 (0)40-18 60 25

